

BOAD IN CONNECTOR

SERIES

9073

CONTACT

STRAIGHT

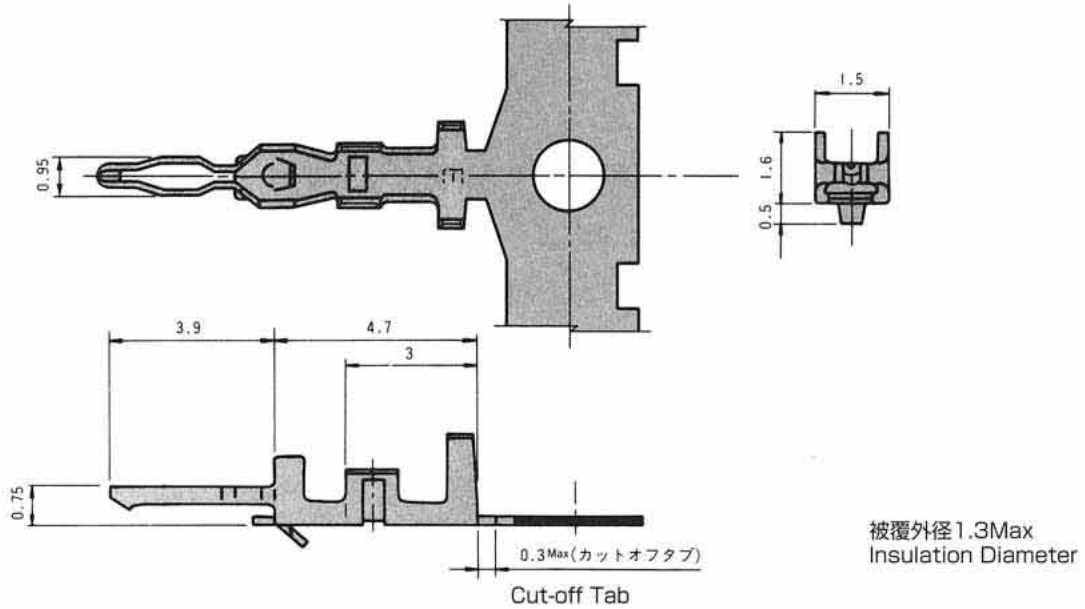

RIGHT ANGLE

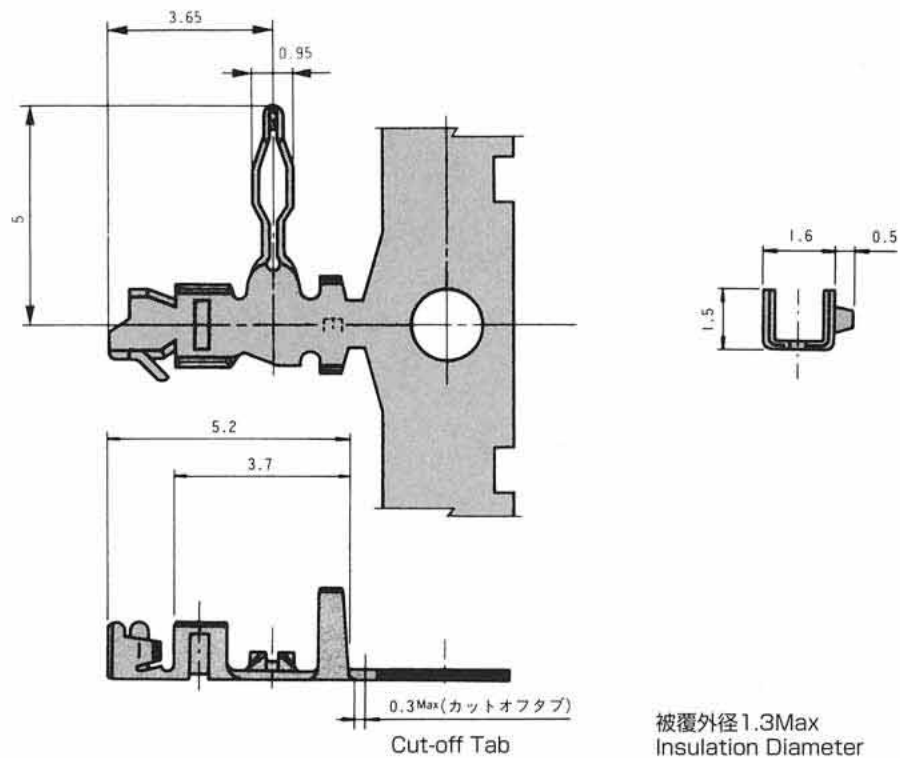

注文コードORDERING CODE

60 9073 XXXX 99 808

形状 Type

0212 : ストレート・リール状 (1リール20,000個) Straight・Chain (1Reel : 20,000Pcs)

0222 : ライトアングル・リール状 (1リール15,000個) Right Angle・Chain (1Reel : 15,000Pcs)

BOARD IN CONNECTOR

SERIES

9073 HOUSING

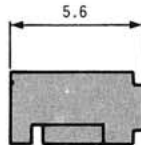
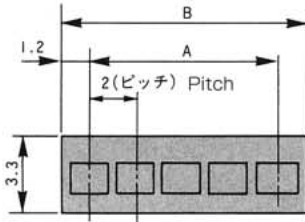

水平型装着断面
Right Angle Type Cross Cut Section

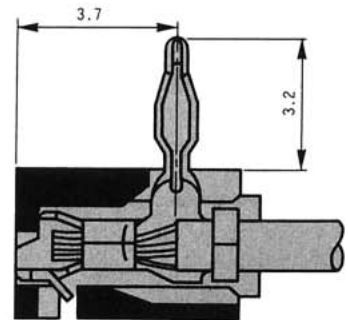

回路No. Circuit No.

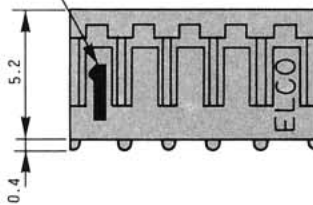

垂直型装着断面
Straight Type Cross Cut Section

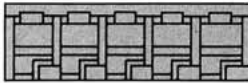
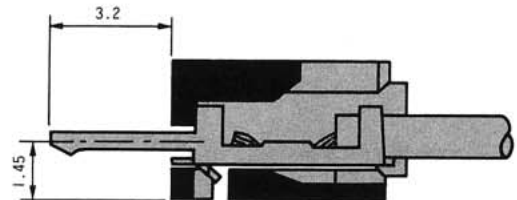

P-Cボード穴寸法 適用基板厚 1.2~1.6mm
P.C. Board Through Hole Dimension t = 1.2~1.6mm

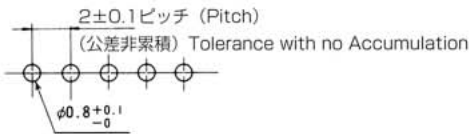

注文コード ORDERING CODE

60 9073 3018 XX 000

極数
Number of Contacts

極数 Number of Contacts	A	B
02	2	4.4
03	4	6.4
04	6	8.4
05	8	10.4
06	10	12.4
07	12	14.4
08	14	16.4
09	16	18.4
10	18	20.4
11	20	22.4
12	22	24.4
13	24	26.4
14	26	28.4
15	28	30.4